

Catálogo de productos



**Industrias
BIPLAXT**



Carretera General Bilbao-Vitoria, Km. 13,700
Barrio Murtaza
48390 Bedia (Vizcaya)
Spain
Tlf: (34) 94-631 35 25 - 52
Fax: (34) 946 313 592
Email: biplaxt@biplaxt.com
www.biplaxt.com



OSCILO BATIENTE CIERRE AL INVERSOR **B-2000**
 TILT&TURN MECHANISM (REVERSING PROFILE LOCKING) **B-2000**



JUEGO BISAGRAS SIMETRICAS
 HOJA PASIVA **B-2016/2017**

SYMMETRIC HINGES
 FOR SECOND WING **B-2016/2017**



KIT ANGULO REENVIO **B-6025**

CORNER TRANSMISSION
 WITH ADDITIONAL LOCKING POINT **B-6025**



JUEGO PASADOR DE ZAMAK
 HOJA PASIVA **B-8010**

SET OF ZAMAK LEVER LATCHES
 FOR SECOND WING
 (REVERSING PROFILE LOCKING) **B-8010**



OSCILO BATIENTE CIERRE AL MARCO **B-2100**
TILT & TURN MECHANISM (FRAME LOCKING) **B-2100**



JUEGO BISAGRAS SIMETRICAS
HOJA PASIVA **B-2016/2017**

SYMMETRIC HINGES
FOR SECOND WING **B-2016/2017**



KIT ANGULO REENVIO **B-6025**

CORNER TRANSMISSION
WITH ADDITIONAL LOCKING POINT **B-6025**

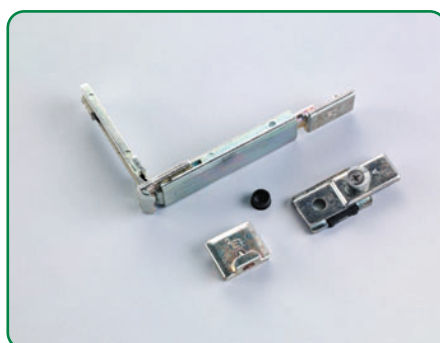

JUEGO PASADOR DE ZAMAK HOJA PASIVA
B-8003

SET OF ZAMAK LEVER LATCHES FOR
SECOND WING (FRAME LOCKING) **B-8003**

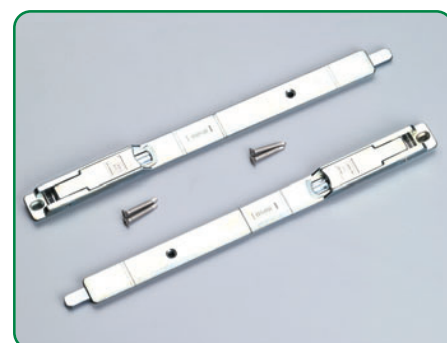

OSCILO BATIENTE CIERRE AL INVERSOR **B-6000**
 TILT & TURN MECHANISM (REVERSING PROFILE LOCKING) **B-6000**



KIT ANGULO REENVIO **B-6025**
 CORNER TRANSMISSION WITH ADDITIONAL
 LOCKING POINT **B-6025**



JUEGO BISAGRAS SIMETRICAS HOJA PASIVA
 SIN REGULACION **B-6027/6028**

SYMMETRIC HINGES FOR SECOND WING
 (NON ADJUSTABLE) **B-6027/6028**



JUEGO PASADOR DE ZAMAK
 HOJA PASIVA **B-8010**

SET OF ZAMAK LEVER LATCHES FOR SECOND
 WING (REVERSING PROFILE LOCKING) **B-8010**



JUEGO BISAGRAS SIMETRICAS HOJA PASIVA
 CON REGULACION **B-6016/6017**

SYMMETRIC HINGES FOR SECOND WING
 (ADJUSTABLE) **B-6016/6017**



OSCILO BATIENTE CIERRE AL MARCO **B-6100**
 TILT & TURN MECHANISM (FRAME LOCKING) **B-6100**



KIT ANGULO REENVIO **B-6025**
 CORNER TRANSMISSION WITH ADDITIONAL
 LOCKING POINT **B-6025**



JUEGO BISAGRAS SIMETRICAS HOJA PASIVA
 SIN REGULACION **B-6027/6028**

SYMMETRIC HINGES FOR SECOND WING
 (NON ADJUSTABLE) **B-6027/6028**



JUEGO PASADOR DE ZAMAK
 HOJA PASIVA **B-8003**

SET OF ZAMAK LEVER LATCHES FOR
 SECOND WING (FRAME LOCKING) **B-8003**

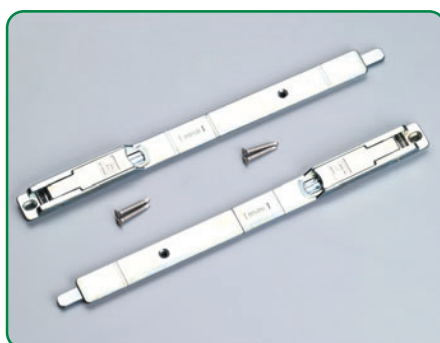

JUEGO BISAGRAS SIMETRICAS HOJA PASIVA
 CON REGULACION **B-6016/6017**

SYMMETRIC HINGES FOR SECOND WING
 (ADJUSTABLE) **B-6016/6017**



COMPAS GRANDE **B-2010**
APERTURA TRADICIONAL

LONG ARM **B-2010**
TRADITIONAL OPENING



CIERRE OCULTO **B-6022**

ADJUSTABLE LOCKING POINT **B-6022**

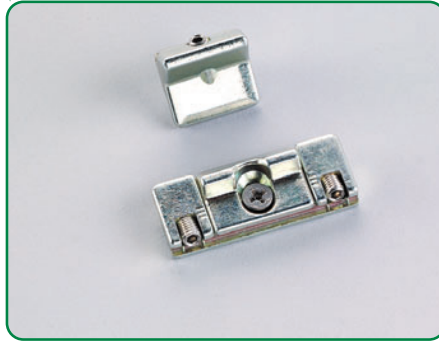

COMPAS PEQUEÑO **B-2011**
APERTURA TRADICIONAL

SHORT ARM **B-2011**
TRADITIONAL OPENING

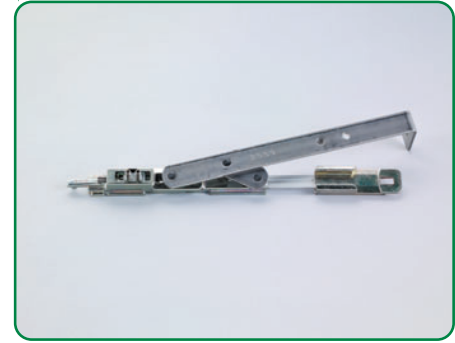

COMPAS GRANDE **B-2050**
APERTURA LOGICA

LONG ARM **B-2050**
TILT FIRST OPENING



COMPAS SUPLEMENTARIO **B-6035**

ADDITIONAL ARM **B-6035**



COMPAS PEQUEÑO **B-2051**
APERTURA LOGICA

SHORT ARM **B-2051**
TILT FIRST OPENING

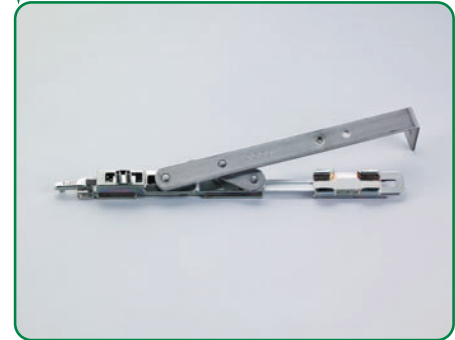

COMPAS GRANDE **B-6010**
APERTURA TRADICIONAL

LONG ARM **B-6010**
TRADITIONAL OPENING



RETENEDOR HOJA PASIVA **B-6024**

SPRING CATCH **B-6024**



COMPAS PEQUEÑO **B-6011**
APERTURA TRADICIONAL

SHORT ARM **B-6011**
TRADITIONAL OPENING

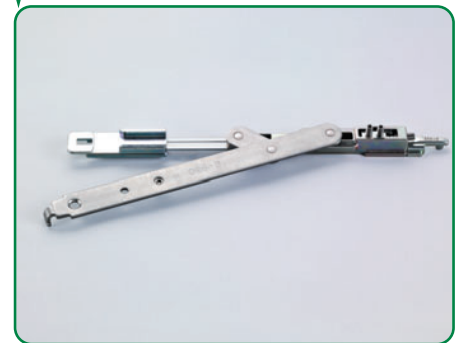

COMPAS GRANDE **B-6050**
APERTURA LOGICA

LONG ARM **B-6050**
TILT FIRST OPENING

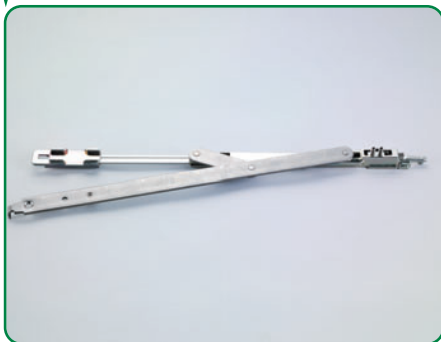

PUNTO DE CIERRE SUPLEMENTARIO **B-6018**

ADDITIONAL LOCKING POINT **B-6018**



COMPAS PEQUEÑO **B-6051**
APERTURA LOGICA

SHORT ARM **B-6051**
TILT FIRST OPENING

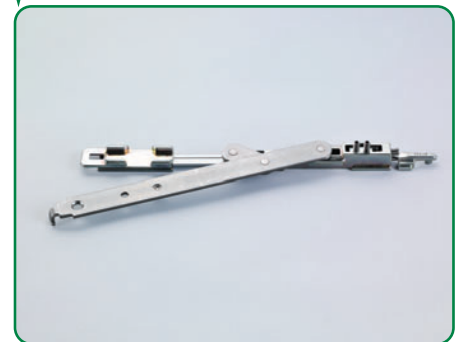

CREMONA **B-3400**

34MM. WIDTH CREMONE BOLT **B-3400**



CREMONA **B-3401**

34MM. WIDTH CREMONE BOLT FOR T&T
B-3401



CREMONA **B-2600**

26MM. WIDTH CREMONE BOLT **B-2600**



CREMONA **B-3400/L**

CREMONE BOLT WITH KEY **B-3400/L**



CREMONA **B-3401/L**

CREMONE BOLT WITH KEY FOR T&T
B-3401/L



CREMONA **B-3000**

30MM. WIDTH CREMONE BOLT **B-3000**



KIT PUNTO DE CIERRE MACHO / MACHO
B-2021

ADDITIONAL LOCKING POINT MALE/MALE
B-2021



MANILLA RECUPERABLE **MR-3000**

DOOR DOUBLE HANDLE **MR-3000**



MANILLA RECUPERABLE **MR-3400**

DOOR DOUBLE HANDLE **MR-3400**



KIT PUNTO DE CIERRE
MACHO / HEMBRA **B-2020**

ADDITIONAL LOCKING POINT
MALE/FEMALE **B-2020**



KIT PASADOR PLETINA 2ª HOJA **B-6013**

OSCILOBATIENTE CIERRE AL INVERSOR
SECOND WING LOCKING KIT FOR T&T
(REVERSING PROFILE LOCKING) **B-6013**



KIT PASADOR PLETINA 2ª HOJA **B-6014**

OSCILOBATIENTE CIERRE AL MARCO
SECOND WING LOCKING KIT FOR T&T
(FRAME LOCKING) **B-6014**





CREMONA APERTURA EXTERIOR
PALA DE 38 m/m **B-5000**

CREMONE BOLT FOR EXTERNAL OPENING
38 MM. LONG BOLTS **B-5000**



CREMONA APERTURA EXTERIOR
PALA DE 42 m/m **B-5001**

CREMONE BOLT FOR EXTERNAL OPENING
42 MM. LONG BOLTS **B-5001**



CIERRE PRECISION **CP-200**

CLOSING HANDLE **CP-200**

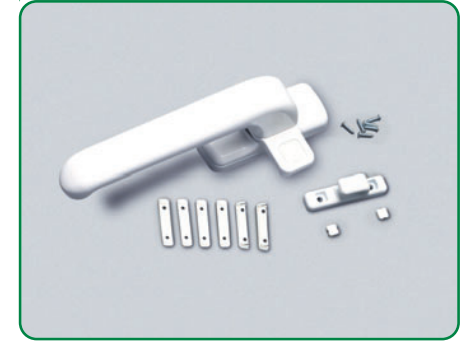

GOLPETE REGULABLE **GR-04**

ADJUSTABLE FINGER CATCH **GR-04**



JUEGO COMPAS RETENEDOR INOX. **GR-05**

ARM STAY SET FOR VASISTAS **GR-05**



KIT 1 HOJA CAMARA EUROPEA **K-4001**

1 WING LOCKING KIT FOR EUROPEAN
GROOVE **K-4001**



KIT 2 HOJAS SIN PASADORES **K-4002**

2 WINGS LOCKING KIT FOR EUROPEAN
GROOVE WITHOUT LATCHES **K-4002**

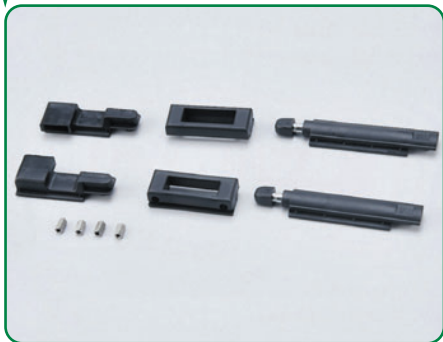

KIT JUEGO PASADOR 2ª HOJA **B-707**

SECOND WING SET OF BOLTS FOR
EUROPEAN GROOVE **B-707**



KIT EUROPEO 2 HOJAS **K-4011**

2 WINGS LOCKING KIT
FOR EUROPEAN GROOVE **K-4011**



CERRADERO SENCILLO **3014**

NYLON SINGLE STRIKER **3014**



CERRADERO DOBLE **3024**

NYLON DOUBLE STRIKER **3024**



TERMINAL EUROPEO **3023**

ROD END EUROPEAN GROOVE **3023**



KIT 2 HOJAS SIN CERRADEROS K-4015
2 WINGS LOCKING KIT FOR T&T WITHOUT STRIKERS K-4015



TAPON VIERTEAGUAS
NYLON DRAINAGE PLUG



NUDOS ESQUINEROS
ROUNDED GLASS BEADING CORNERS



ESCUADRAS ALINEAMIENTO INOX.
STAINLESS STEEL ALIGNMENT ANGLES

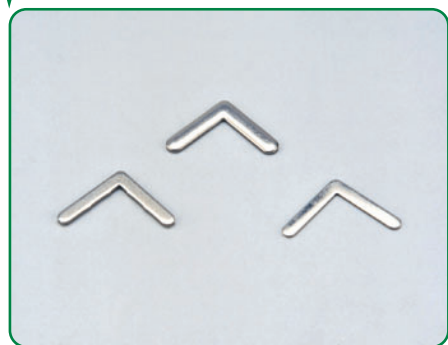

CLIPS DE JUNQUILLO
CLIPS FOR GLASS BEADING

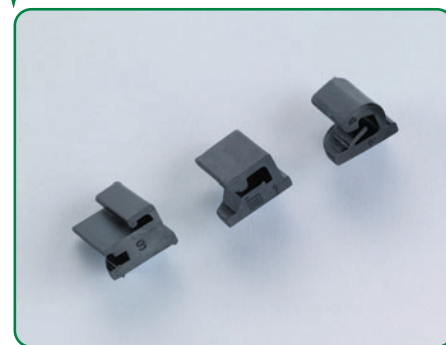

TAPON DE DESAGÜE CON LAMINA
NYLON DRAINAGE PLUG WITH INNER WIND SCREEN

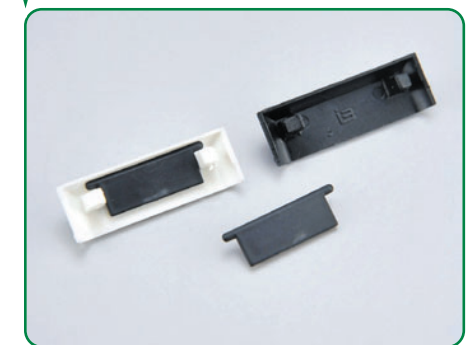

JUEGO TAPON INVERSOR S/ALFIL SIN ROTURA
A-100

REVERSING PROFILE SEAL PLUG SET FOR ALFIL NON THERMAL BREAK SERIES
A-100

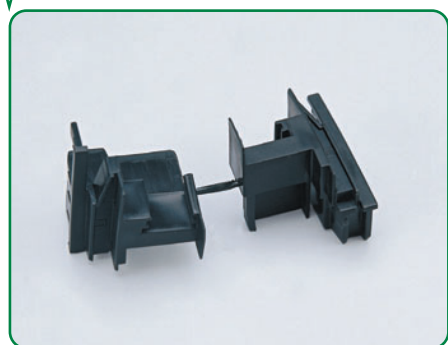

JUEGO TAPON INVERSOR S/ALFIL CON ROTURA
A-101

REVERSING PROFILE SEAL PLUG SET FOR ALFIL THERMAL BREAK SERIES
A-101

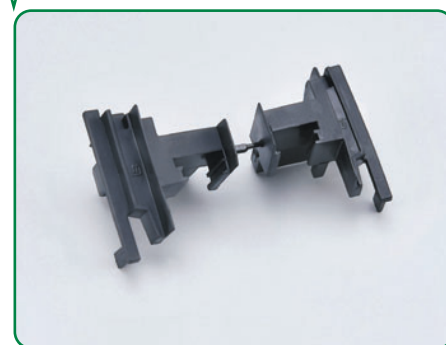

JUEGO TAPON INVERSOR S/ALFIL TUBULAR CON ROTURA
A-099

REVERSING TUBULAR PROFILE SEAL PLUG FOR ALFIL THERMAL BREAK SERIES
A-099

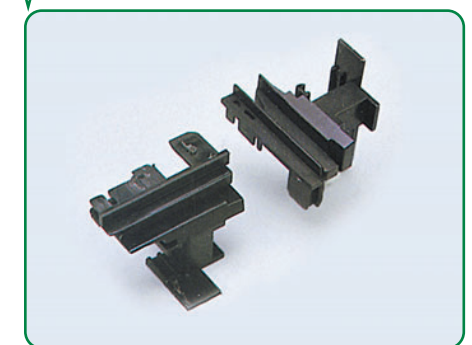

JUEGO TAPON INVERSOR SERIE A-40
B-100

REVERSING PROFILE SEAL PLUG A-40 SERIES
B-100

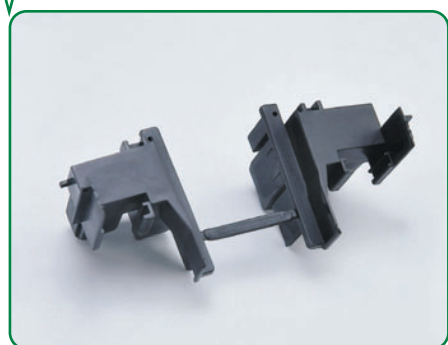

ESCUADRAS ALINEACION POLYAMIDA
A-102 S/ALFIL B-101 S/ A-40

NYLON ALIGNMENT ANGLES ALFIL SERIES
A-102 AND B-101



ASA TIRADOR CIERRE EMBUTIDO
AT-16

ALUMINIUM PULL HANDLE FOR EMBEDDING LOCK
AT-16





CIERRE EMBUTIDO ALUMINIO **CA-15**

ALUMINIUM EMBEDDING LOCK **CA-15**



CIERRE EMBUTIDO NYLON **CE-5**

NYLON EMBEDDING LOCK **CE-5**

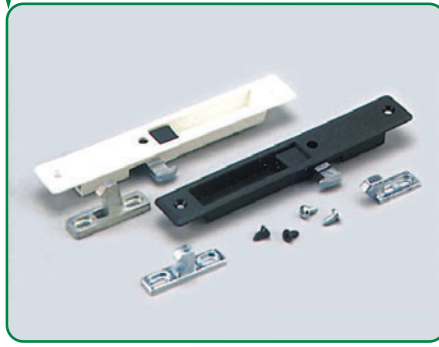

CIERRE EMBUTIDO NYLON **CE-5P**

NYLON EMBEDDING LOCK **CE-5P**

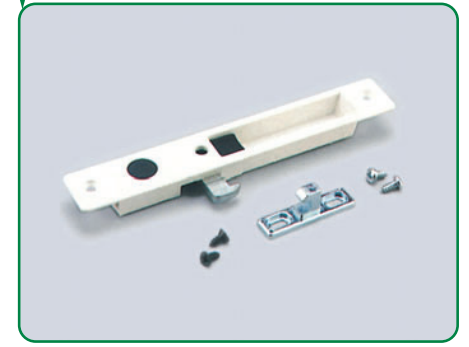

CIERRE EMBUTIDO NYLON **CE-10**

NYLON EMBEDDING LOCK **CE-10**

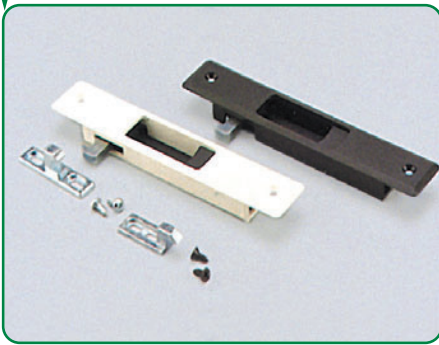

CIERRE EMBUTIDO NYLON **CE-52**

NYLON EMBEDDING LOCK **CE-52**

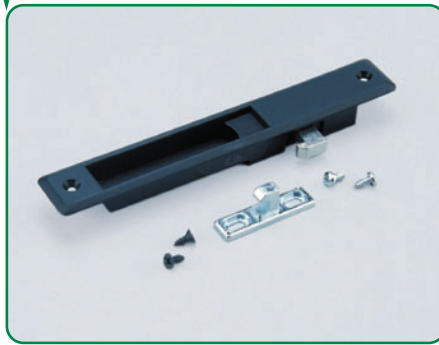

RUEDA **RMR Y RIR**

ROLLERS **RMR AND RIR**

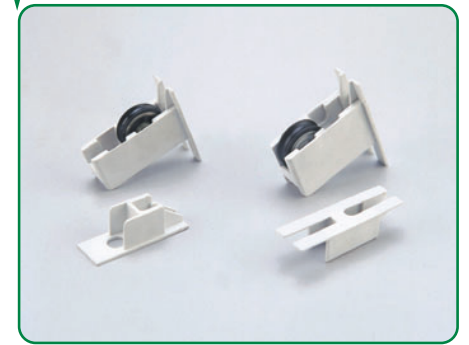

RUEDA **R-750 Y TANDEM T-750**

ROLLER **R-750 AND TANDEM ROLLER T-750**

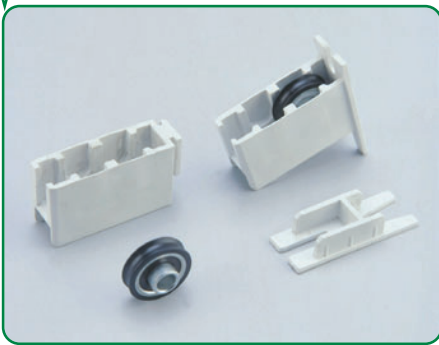

RUEDA **G-90 Y TANDEM TG-90**

ROLLER **G-90 AND TANDEM ROLLER TG-90**

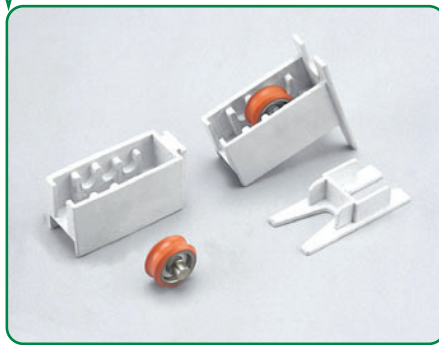

RUEDA **COR-5000-G Y TANDEM T-COR-5000-G**

ROLLER **COR-5000-G AND TANDEM ROLLER T-5000-G**

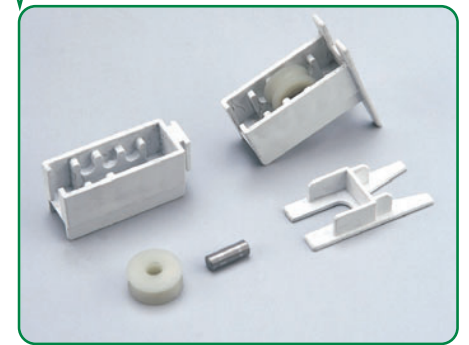

RUEDA **R-2000**

ROLLER **R-2000**



RUEDAS **DIAMANTE Y DIAMANTE CLIMALIT**

ROLLER **DIAMANTE AND DIAMANTE CLIMALIT SERIES**



RUEDA **COR-5000**

ROLLER **COR-5000**



MANILLON ALUMINIO Mod. **MARTE**

DOOR ALUMINIUM PULL HANDLE **MARTE**

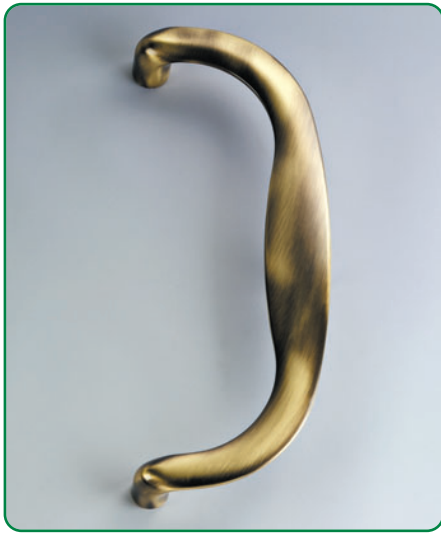

MANILLON ALUMINIO Mod. **SATURNO**

DOOR ALUMINIUM PULL HANDLE **SATURNO**



MANILLON ALUMINIO Mod. **SELENE**

DOOR ALUMINIUM PULL HANDLE **SELENE**



MANILLON **VENUS-4**

DOOR PULL HANDLE **VENUS-4**



MANILLON **VENUS-2**

DOOR PULL HANDLE **VENUS-2**



MANILLON **VENUS-3**

DOOR PULL HANDLE **VENUS-3**



KIT MONTAJE JUEGO ALUMINIO

BACK TO BACK FITTING SET
ALUMINIUM HANDLE



MANILLON **VENUS-5**

DOOR PULL HANDLE **VENUS-5**



KIT MONTAJE INDIVIDUAL

SINGLE HANDLE FITTING SET

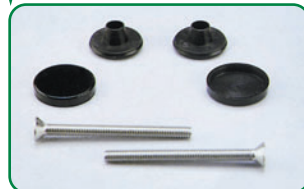

KIT MONTAJE JUEGO **VENUS**

BACK TO BACK FITTING
SET **VENUS**



MANILLON **VENUS-1**

DOOR PULL HANDLE **VENUS-1**



MULTIPUNTO

MULTIPOINT LOCKING ESPAGNOLETTE

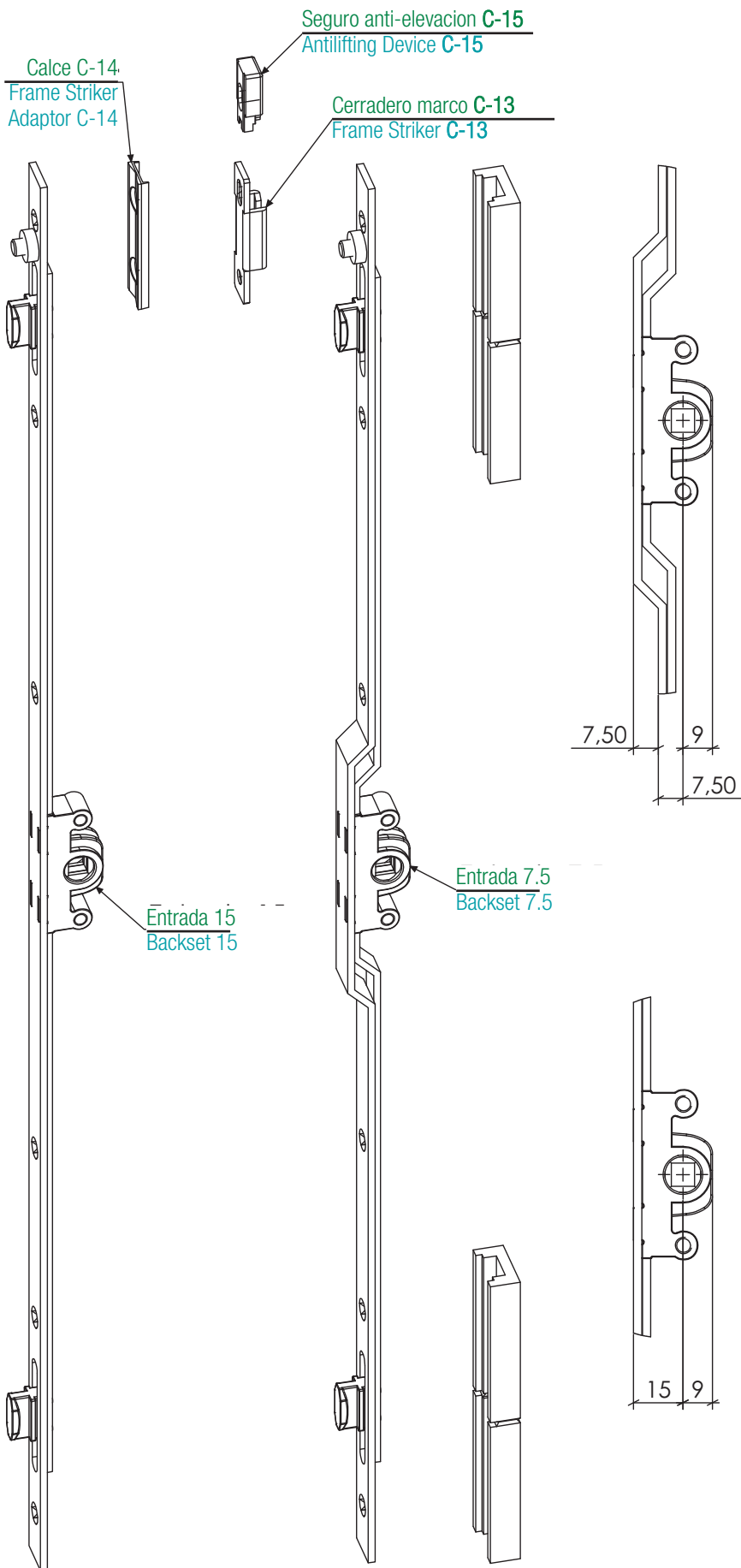

MULTIPUNTO ENTRADA 7.5 BACKSET 7.5

Referencia Reference	Longitud Length	Puntos de cierre Locking points
B-7007-0270	270 m.m.	1
B-7007-0600	600 m.m.	2
B-7007-1000	1000 m.m.	2
B-7007-1600	1600 m.m.	3
B-7007-1800	1800 m.m.	3

MULTIPUNTO ENTRADA 15 BACKSET 7.5

Referencia Reference	Longitud Length	Puntos de cierre Locking points
B-7015-0210	210 m.m.	1
B-7015-0600	600 m.m.	2
B-7015-1000	1000 m.m.	2
B-7015-1600	1600 m.m.	3
B-7015-1800	1800 m.m.	3

MANILLAS

HANDLES

UÑERO **B-7100**
(MANILLA DE ENCASTRE)

EMBEDDING LOCK FOR MULTIPOINT LOCKING SLIDING
ESPAGNOLETTE **B-7100**



MANILLA **B-7900**

HANDLE **B-7900**



MANILLA **B-7300**

HANDLE **B-7300**



MANILLA **B-7500**

HANDLE **B-7500**



CALCES Y ACCESORIOS

ADAPTORS AND ACCESSORIES

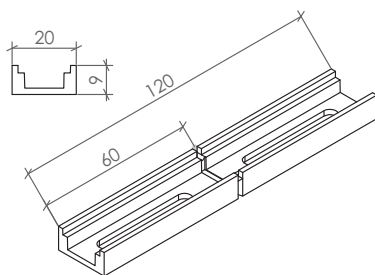

B-20-9

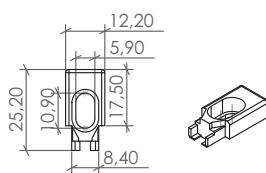

Seguro antielevación C-15
Antilifting device C-15

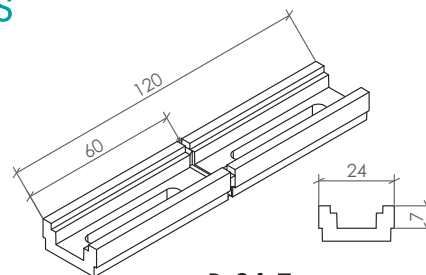

B-24-7

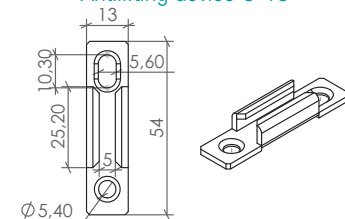

Cerradero marco C-13
Frame Striker C-13

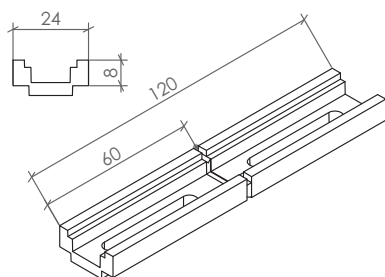

B-24-8

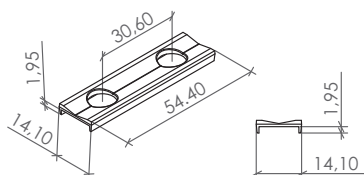

Calce C-14
Frame Striker Adaptor C-14

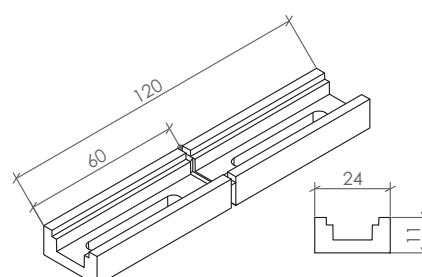

B-24-11



KIT K-4000 1 HOJA S-40/18 y S-40/20

1 WING LOCKING KIT FOR 40/18 AND 40/20 SERIES **K-4000**

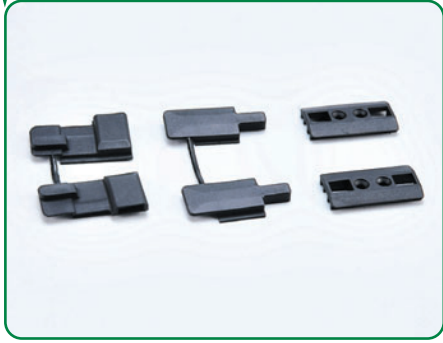

KIT K-4018 y K-4020 S-40/18 y S-40/20 TERMINALES DE ZAMAK

1 WING LOCKING KIT WITH ZINC ROD END FOR S-40/18 y S-40/20 **K-4018 AND K-4020**

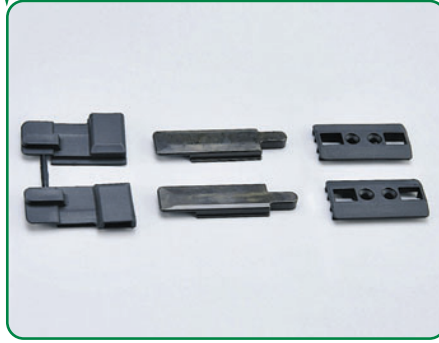

KIT PASADORES K-4005 y K-4006 S-40/20 y S-40/18

SECOND WING SET OF BOLTS FOR 40/20 AND 40/18 SERIES **K-4005 AND K-4006**

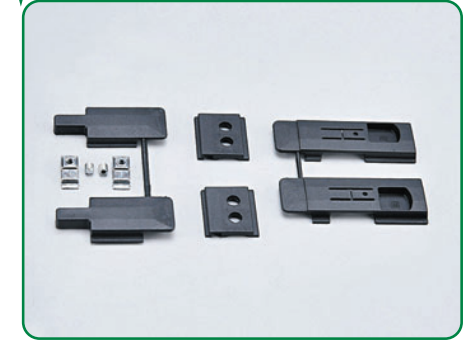

KIT 2 HOJAS K-4003 S-40/20

2 WINGS LOCKING KIT FOR 40/20 SERIES **K-4003**

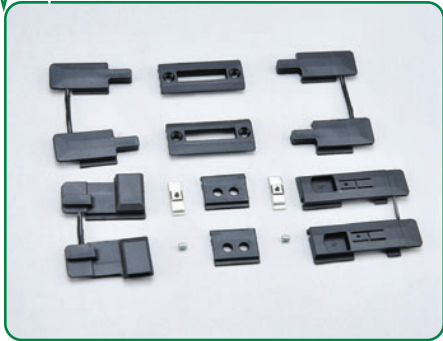

KIT 2 HOJAS K-4004 S-40/18

2 WINGS LOCKING KIT FOR 40/18 SERIES **K-4004**

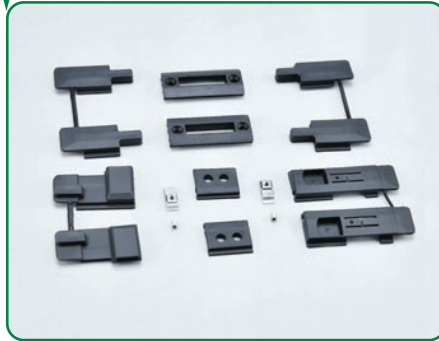

KIT 2 HOJAS K-4019 y K-4021 S-40/18 y S-40/20 TERMINAL DE ZAMAK

2 WINGS LOCKING KIT WITH ZINC ROD END FOR 40/18 AND 40/20 SERIES **K-4019 AND K-4020**



JUEGO TAPON INVERSOR K-4009 S-40/20

SET OF REVERSING PROFILE SEALING PLUGS 40/20 SERIES **K-4009**

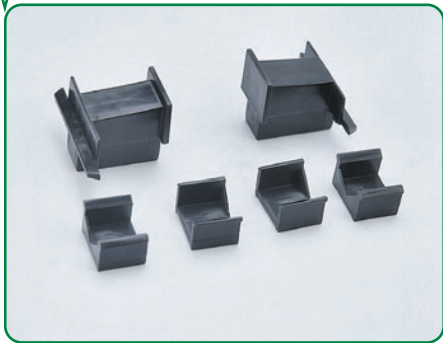

JUEGO TAPON INVERSOR K-4010 S-40/18

SET OF REVERSING PROFILE SEALING PLUGS **K-4010** 40/18 SERIES

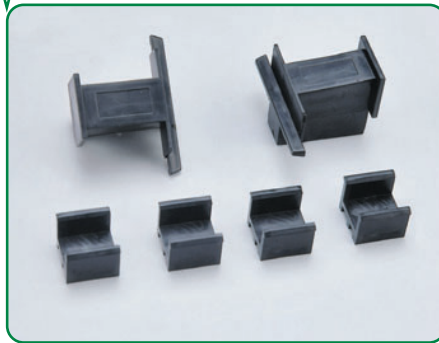

JUEGO TAPON CONDENSACION A-104 S/ALFIL

SET OF WATER SEALING PLUGS ALFIL SERIES **A-104**

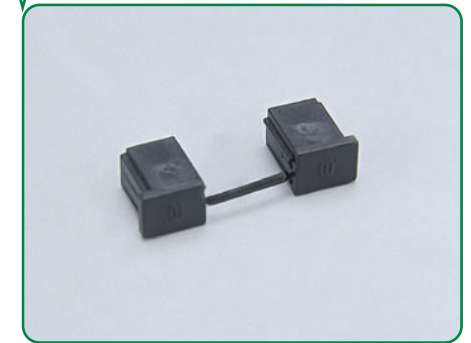

ESCUADRAS DE PLASTICO REFORZADAS Y SIN REFUERZO DE VENTANA

PLASTIC CORNER JOINTS REINFORCED AND NON REINFORCED FOR WINDOWS



ESCUADRAS DE PLASTICO REFORZADAS DE PUERTA

STEEL REINFORCED PLASTIC CORNER JOINTS FOR DOORS



ESCUADRAS DE PLASTICO DE PREMARCO SIN REFUERZO

PLASTIC CORNER JOINTS FOR 90° CUT PROFILES





Industrias BIPLAXT

Catálogo de productos



BEGALPLAS

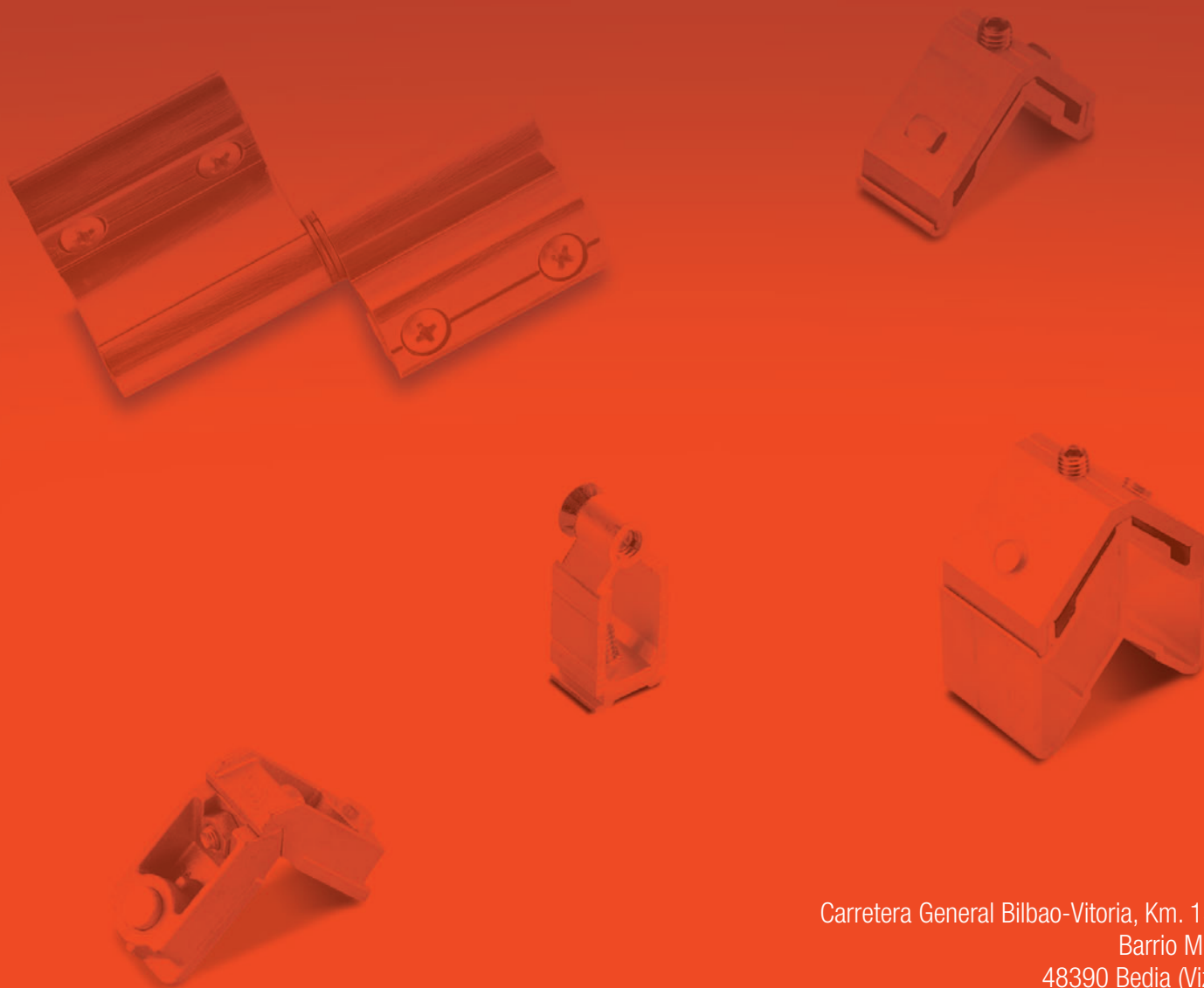

Carretera General Bilbao-Vitoria, Km. 13,700
Barrio Murtaza
48390 Bedia (Vizcaya)
Spain
Tlf: (34) 94-631 35 25 - 52
Fax: (34) 946 313 592
Email: biplaxt@biplaxt.com
www.biplaxt.com



**BISAGRAS CAMARA EUROPEA CHAPA INOX. O DE ZAMAK
EJE INOX. O ACERO CINCADO P-6012**

HINGES FOR EUROPEAN GROOVE/ZINC OR STAINLESS STEEL
PLATES/GALVANISED OR STAINLESS STEEL PIVOT **P-6012**



**BISAGRAS CAMARA EUROPEA DE 3 PALAS CHAPA INOX. O DE ZAMAK
EJE INOX. O ACERO CINCADO P-6014**

3 WINGS HINGES FOR EUROPEAN GROOVE/ZINC OR STAINLESS
STEEL PLATES/GALVANISED OR STAINLESS STEEL PIVOT **P-6014**



**BISAGRA CAMARA EUROPEA CHAPAS INOX. Ó EXCENTRICAS INOX.
EJE INOX. O ACERO CINCADO P-6001**

HINGES FOR EUROPEAN GROOVE/STAINLESS STEEL PLATES OR
ECCENTRICS/GALVANISED OR STAINLESS STEEL PIVOT **P-6001**

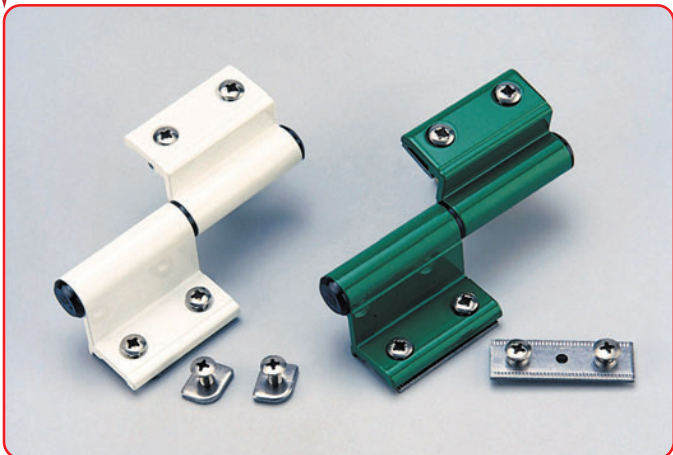

**BISAGRA CAMARA EUROPEA 3ª HOJA CHAPA INOX. Ó DE ZAMAK
EJE INOX. O ACERO CINCADO P-6020**

3RD. WING HINGE FOR EUROPEAN GROOVE/ZINC OR STAINLESS
STEEL PLATES/GALVANISED OR STAINLESS STEEL PIVOT **P-6020**



**BISAGRA CAMARA EUROPEA NUDO 16
CHAPA ZAMAK P-6009**

HINGE FOR EUROPEAN GROOVE 16 MM. DIAM.
ZINC PLATES **P-6009**



BISAGRA S/ALUMAFEL P-6011

HINGE FOR ALUMAFEL SERIES **P-6011**





BISAGRAS S- 40/18 y S-40/20
CHAPA INOX. P-6000

HINGES FOR SERIES 40/18 AND 40/20
STAINLESS STEEL PLATES P-6000

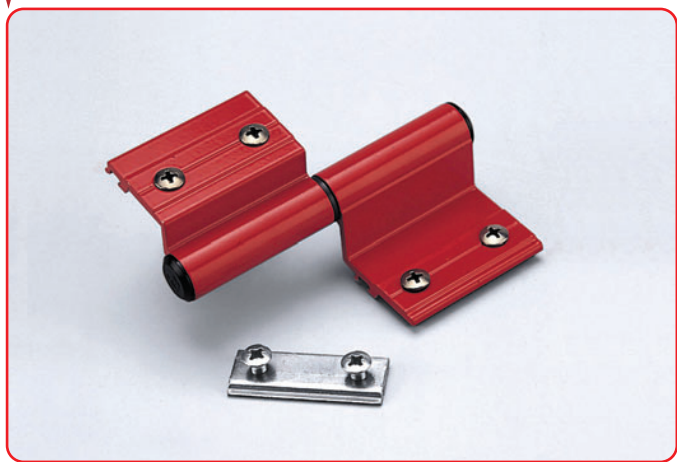

BISAGRAS S-40/18 y S-40/20
CHAPA DE ZAMAK P-6010

HINGES FOR SERIES 40/18 AND 40/20
ZINC PLATES P-6010



BISAGRA 3 PALAS S-40/18 y S-40/20
CHAPA DE ZAMAK P-6013

3 WINGS HINGE FOR SERIES 40/18 AND 40/20
ZINC PLATES P-6013

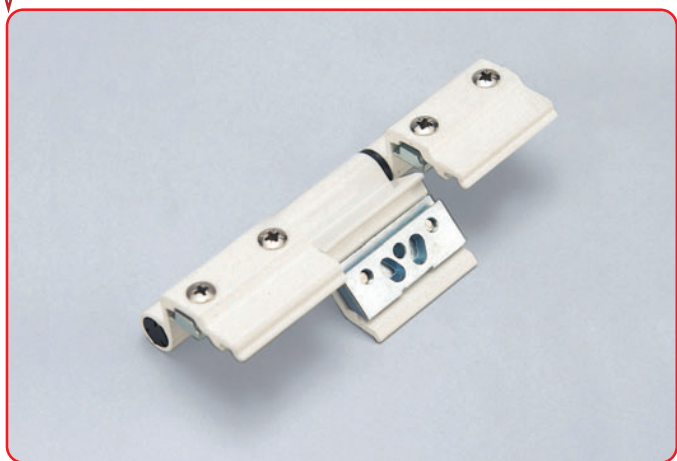

BISAGRA RESALTE CANARIAS
CHAPA DE ZAMAK P-6015

JUT-OUT HINGE CANARIAS SERIES
ZINC PLATES P-6015



BISAGRA ACORAZADA DE PUERTA ENRRASADA P-6003

IRONCLAD HINGE FOR LEVEL DOORS P-6003

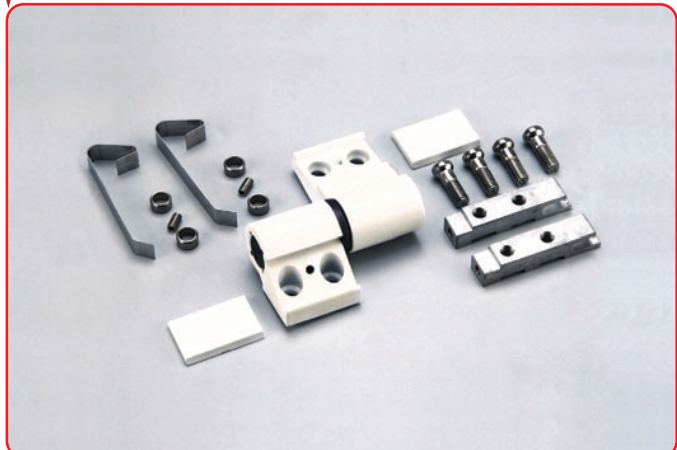

BISAGRA ACORAZADA DE PUERTA CON RESALTE P-6004

IRONCLAD HINGE FOR JUT-OUT DOORS P-6004



ESCUADRAS DE BLOQUEO DE VENTANA
TETON RECTANGULAR

WINDOW RECTANGULAR BUTTON
EXTRUDED ALUMINIUM CORNER JOINTS



ESCUADRAS DE BLOQUEO DE PUERTA
TETON RECTANGULAR

DOOR RECTANGULAR BUTTON
EXTRUDED ALUMINIUM CORNER JOINTS



ESCUADRAS DE BLOQUEO DE VENTANA
TETON REDONDO

WINDOW ROUND BUTTON
EXTRUDED ALUMINIUM CORNER JOINTS



ESCUADRAS DE BLOQUEO DE PUERTA
TETON REDONDO

DOOR ROUND BUTTON
EXTRUDED ALUMINIUM CORNER JOINTS



ESCUADRAS EUROPEAS TORNILLO EN VERTICE
DE VENTANA Y PUERTA

1 SCREW ON VERTEX WINDOW AND DOOR
EXTRUDED ALUMINIUM CORNER JOINTS

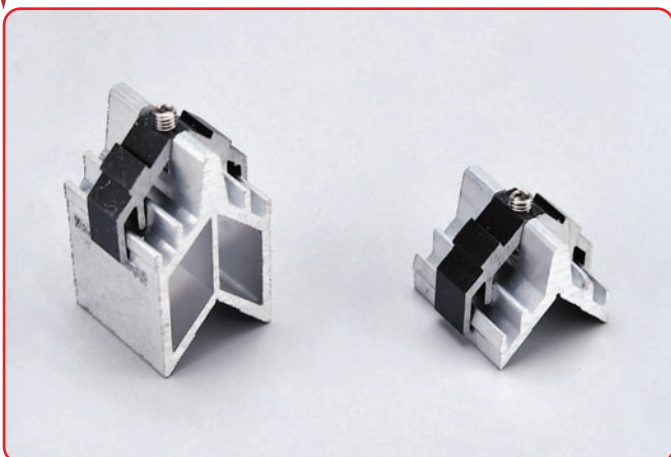

UNIONES EUROPEAS DE TRAVESAÑO CERRADAS
EUROPEAN GROOVE WINDOW AND DOOR CONNECTORS





ESCUADRAS 2 TORNILLOS

2 SCREWS ALUMINIUM CORNER JOINTS

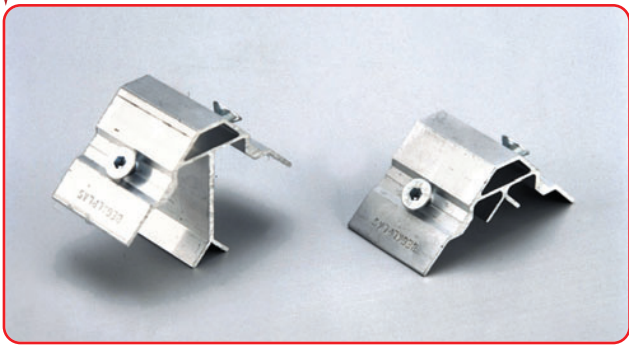

UNIONES ALTAS S-40/18

TOP CONNECTORS SERIES 40/18

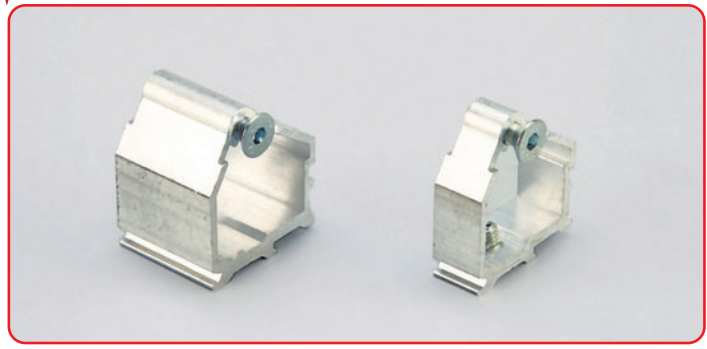

TROQUEL MANUAL Z-500

MANUAL PRESS Z-500



TROQUEL NEUMATICO Z-505

PNEUMATIC PRESS Z-505



ESCUADRAS DE FUNDICION DE ALUMINIO MONTICELLI

DIE-CAST ALUMINIUM CORNER JOINTS MONTICELLI





BEGALPLAS, S.L.